



dvd±rw SLIM

DESIGN BY F·A·PORSCHE



Register your product online  
for free technical support:  
[www.lacie.com/register.htm](http://www.lacie.com/register.htm)

go directly to manual

## Table of Contents

|   |           |
|---|-----------|
| Foreword  | 2         |
| Precautions   | 4         |
| <b>1. Unpacking Your LaCie Drive</b>                            | <b>6</b>  |
| 1.1. Minimum System Requirements                                | 7         |
| 1.1.1. Hardware Requirements                                    | 7         |
| 1.1.2. Software Requirements                                    | 7         |
| <b>2. Getting Connected</b>                                     | <b>8</b>  |
| 2.1 Install the Recording Software                              | 9         |
| 2.2 Connect the Power Supply and Switch On the Drive            | 10        |
| 2.3 Connect the USB 2.0 Cable to the Drive and to Your Computer | 12        |
| <b>3. Using Your LaCie Drive</b>                                | <b>13</b> |
| 3.1. Supported DVD and CD Formats                               | 13        |
| 3.1.1. CD and DVD Media Definitions                             | 14        |
| 3.1.2. DVD-Video Zone   | 15        |
| 3.2. Inserting Discs  | 16        |
| 3.3. Ejecting Discs   | 17        |
| 3.4. Emergency Ejection of Discs                                | 17        |
| 3.5. Accessing Discs  | 18        |
| 3.6. Writing Discs  | 18        |
| <b>4. Helpful Information</b>                                   | <b>20</b> |
| 4.1. Advice for Optimizing USB 2.0 Connections                  | 20        |
| 4.1.1. What Is USB 2.0?   | 20        |
| 4.1.2. Disconnecting USB 2.0 Devices                            | 21        |
| 4.1.3. Data Transfers   | 22        |
| 4.2 User Advice on MPEG-II Decoders                             | 23        |
| 4.3 File System Formats - Definitions                           | 23        |
| <b>5. Troubleshooting</b>                                       | <b>24</b> |
| <b>6. Contacting Customer Support</b>                           | <b>30</b> |
| <b>7. Warranty</b>  | <b>32</b> |

### Copyrights

Copyright © 2003 LaCie. All rights reserved. No part of this publication may be reproduced, stored in a retrieval system, or transmitted in any form or by any means, electronic, mechanical, photocopying, recording or otherwise, without the prior written consent of LaCie.

### Trademarks

Apple, Mac and Macintosh are registered trademarks of Apple Computer, Inc. Microsoft, Windows, Windows 98 SE, Windows Millennium Edition, Windows 2000 and Windows XP are registered trademarks of Microsoft Corporation. All trademarks mentioned in this manual are the property of their respective owners.

### Changes

The material in this document is for information only and is subject to change without notice. While reasonable efforts have been made in the preparation of this document to assure its accuracy, LaCie assumes no liability resulting from errors or omissions in this document, or from the use of the information contained herein. LaCie reserves the right to make changes or revisions in the product design or the product manual without reservation and without obligation to notify any person of such revisions and changes.

### Federal Communications Commission Radio Frequency Interference Statement (FCC)

WARNING: Changes or modifications to this unit not expressly approved by the party responsible for compliance could void the user's authority to operate the equipment. This equipment has been tested and found to comply with the limits for a Class B digital device, pursuant to Part 15 of the FCC Rules. These limits are designed to provide reasonable protection against harmful interference when the equipment is operated in a commercial environment. This equipment generates, uses, and can radiate radio frequency energy, and if not installed and used in accordance with the instructions, may cause harmful interference to radio communications.

However, there is no guarantee that interference will not occur in a particular installation. If this equipment does cause harmful interference to radio or television reception, which can be determined by turning the equipment off and on, the user is encouraged to correct the interference by one of the following measures:

- Reorient or relocate the receiving antennas.
- Increase the separation between the equipment and the receiver.
- Connect the equipment into an outlet on a circuit different from that to which the receiver is connected.
- Consult the reseller or an experienced radio/TV technician for help.

Shielded cables and I/O cards must be used for this equipment to comply with the relevant FCC regulations.

This device complies with Part 15 of the FCC rules. Operation is subject to the following two conditions: (1) this device may not cause harmful interference, and (2) this device must accept any interference received, including interference that may cause undesired operation.

LaCie Slim Optical Drive USB 2.0  
sU2



Tested To Comply  
With FCC standards

FOR HOME OR OFFICE USE

### **Canada Compliance Statement**

This Class A digital apparatus meets all requirements of the Canadian Interference-Causing Equipment Regulations.

### **Manufacturer's Declaration for CE Certification**

We hereby certify that this device is in compliance with both the EMC Directive (89/336/EEC) and the Low Voltage Directive (73/23/EEC) issued by the Commission of the European Community.

Compliance with these directives implies conformity to the following European Norms:

Class B EN60950, EN55022, EN50082-1, EN61000-3-2

With reference to the following conditions:

73/23/EEC Low Voltage Directive

89/336/EEC EMC Directive

### **Laser Products**

This equipment is certified to comply with DHHS Rule 21 CFR Chapter I, subchapter J in effect as of date of manufacture. This equipment is classified as a Class I Laser product and no hazardous laser radiation is emitted outside the drive.



## Health, Safety and General Use Precautions

The drive you have just purchased includes a laser diode device, which classifies it as a "Laser Class I" product. This laser is not dangerous for the user under normal operating conditions. However, we strongly advise you not to place any reflective objects in the disc loading system, due to the risk of exposure to laser emissions that may be reflected by such objects.

Always follow the basic precautions listed below to use your LaCie drive safely and correctly. Respecting these guidelines will help to avoid the possibility of personal injury to yourself or others, as well as to prevent damage to your device and other computer equipment. These precautions include, but are not limited to, the following:

### Health and Safety Precautions:

- Read this User's Manual carefully, and follow the correct procedure when setting up the device.
- Do not look inside or place your hand over the open DVD/CD media tray. Never look directly or indirectly (with a mirror) at the laser diode, even when the device is not in operation. If you expose your eyes or skin to the laser inside you drive, you risk damage or loss of your vision or other personal injury.
- Do not open your drive or attempt to disassemble or modify it. Never insert any metallic object into the drive to avoid any risk of electrical shock, fire, short-circuiting or dangerous emissions. Your drive contains no user-serviceable parts. If it appears to be malfunctioning, have it inspected by qualified LaCie service staff.
- Never expose your device to rain or use it near water or in damp or wet conditions. Never place containers on it containing liquids that may spill into its openings. Doing so increases the risk of electrical shock, short-circuiting, fire or personal injury.
- Make sure that the computer and drive are electrically grounded. If the devices are not grounded, there is an increased risk of electrical shock.
- Do not listen to audio with headphones at an excessive volume for prolonged periods of time. Doing so increases the risk of hearing damage or loss.
- Before listening to music with your drive, set the volume control to minimum. Sudden bursts of sound at loud volumes can cause immediate hearing damage or loss.

### General Use Precautions:

- Do not expose the drive to temperatures outside the range of 5° C to 40° C (41° F to 104° F) during operation. Doing so may damage the drive or disfigure its casing. Avoid placing your drive near a source of heat or exposing it to sunlight (even through a window). Inversely, placing your drive in an environment that is too cold or humid may damage the unit.
- Do not block the ventilation outlets on the rear of the drive. These help to keep your drive cool during operation. Blocking the ventilation outlets may cause damage to your drive and cause an increased risk of short-circuiting or fire.
- Always unplug the drive if there is a risk of lightning or if it will not be used for an extended period of time. Otherwise, there is an increased risk of electrical shock, short-circuiting or fire.
- Do not place heavy objects on top of the drive or use excessive force on its buttons, connectors and tray. Doing so increases the risk of damage to the device.
- Always place your drive in a horizontal position before using it. Otherwise, it may fall, causing damage to the device and / or corruption or loss of data.
- Always remove the disc from the disc tray before transporting your drive. Otherwise, written data may be destroyed or the drive's internal components may be damaged.
- Never use excessive force on the disc loading system; discs should be inserted effortlessly into your drive. If you detect a problem, consult the [Troubleshooting](#) section.
- Protect your drive from excessive exposure to dust during use or storage. Dust can build up inside the device, increasing the risk of damage or malfunction.
- Never use benzene, paint thinners, detergent or other chemical products to clean the outside of the drive. Such products will disfigure and discolor the front panel and casing. Instead, use a soft, dry cloth to wipe the device.

## 1. Unpacking Your LaCie DVD+/-RW Drive

Become the producer, director and star of your own DVD epics, the DJ with the freshest music compilations, and the IT expert that archives all of your important files and data. Use your LaCie DVD+/-RW Drive in conjunction with the included software to create a wide-range of multimedia projects, view DVDs and backup critical volumes and folders.

Within minutes you'll be connected and creating. There's no worries about compatibility, either, because the LaCie DVD+/-RW Drive supports all the major DVD formats and works with both Macs and PCs.

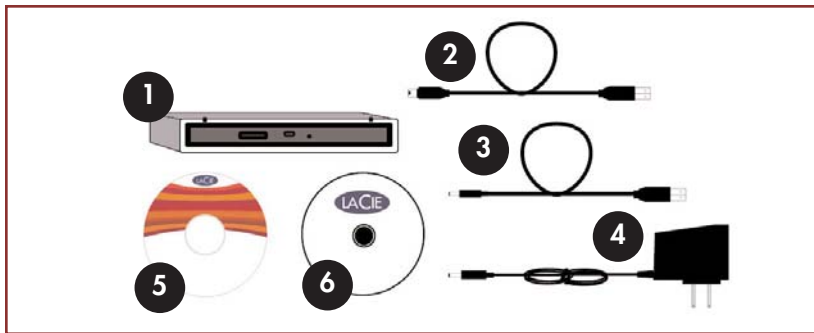

- 1 LaCie Slim DVD+/-RW Drive
- 2 Hi-speed USB 2.0 certified cable
- 3 USB Power Sharing Cable
- 4 Power supply
- 5 LaCie DVD Utilities CD-ROM
- 6 Blank LaCie DVD-R media (1)

## 1.1. Minimum System Requirements

### 1.1.1. Hardware requirements:

- Computer with USB 2.0 or 1.1 interface\*



**\*Tech Note:** \*To achieve USB 2.0 speeds, your drive must be connected to a USB 2.0 host port. If it is connected to a USB 1.1 port, your drive will operate at USB 1.1 speeds. For more details, see [4.1. Advice for Optimizing USB 2.0 Connections](#).

### 1.1.2. System requirements:

#### Minimum:

- Windows 98 SE (Second Edition), Windows Me (Millennium Edition), Windows 2000, or Windows XP
- Intel Pentium II/350MHz compatible processor or greater; 64MB RAM minimum
- 800MB Free Space on Hard Drive for full software install
- Mac OS 9.1 (Apple FireWire support 2.2 and greater) and 10.1.2 or later
- Mac G3 processor; 64MB RAM minimum

#### Recommended:

- Windows 2000, or Windows XP
- 1.2GHz processor or greater; 256MB RAM
- Mac OS 9.2.2 or Mac OS 10.2 or later
- Mac G4 processor; 256MB RAM

### 1.1.3. Additional Requirements for DVD Playback and Pre-mastering:

- Video Card supporting DirectDraw Standard
- Audio Card supporting 44.1KHz or 48KHz sampling rate
- Monitor Resolution of 1024 x 768, 24-bit color
- Microsoft DirectShow 6.4 or greater

### 1.1.4. Additional Requirements for DV Capturing and DVD Authoring:

- Intel Pentium II/600Mhz processor or greater for video capture
- Intel Pentium II/400Mhz processor or greater for video authoring
- 128MB RAM minimum (256MB is recommended)
- Monitor Resolution of 1024 x 768, 16-bit color
- 5GB of free space for temporary caching of 4.7GB of DVD-Video
- 10GB or greater (20GB is suggested) Hard Drive for storing video and audio files



## 2. Getting Connected

Follow these steps to quickly get your LaCie Drive powered on and connected to your computer. Click on a step to get started!

[2.1. Install the Recording Software](#)

[2.2. Connect the Power Supply and Switch On the Drive](#)

[2.3. Connect the USB 2.0 Cable to Your LaCie Drive and to Your Computer](#)

Once you've gotten the drive powered on and connected to your computer, move on to section [3. Using Your LaCie Drive](#) for important information on how to utilize your drive.



## Step 2.1. –

From your LaCie DVD Utilities CD-ROM, open the software folders, click on the install icons (Windows Users: click on the Setup.exe icon; Mac Users: double-click the Installer icon) of the various programs and follow the on-screen instructions to install the programs. For more information about the various programs, please refer to your LaCie DVD Software Guide, located on the LaCie DVD Utilities CD-ROM, or refer to the Help sections of the specific software program.

### Windows Users



### Mac Users



## Windows 98 SE and Windows Me Users!

Before continuing, first install this important software to help you configure and manage your LaCie drive.

*From the LaCie DVD Utilities CD-ROM:*

A) Double-click the **USB 2.0 Drivers** folder.

B) Double-click on the **LaCie\_USB\_Driver\_Install.exe** icon. The LaCie USB2 Storage Driver screen will appear. Click on **Next**.

C) Installation will finish automatically.

## Step 2.2 –

### **Connect the power supply and switch on the drive.**

Your LaCie Drive includes two types of external power supplies: an external power supply (Option A) and a USB Power Sharing Cable (Option B). Use Option A when you are using your drive near an electrical outlet, and use Option B when you do not have access to an electrical outlet and wish to draw power from your computer.

#### Option A

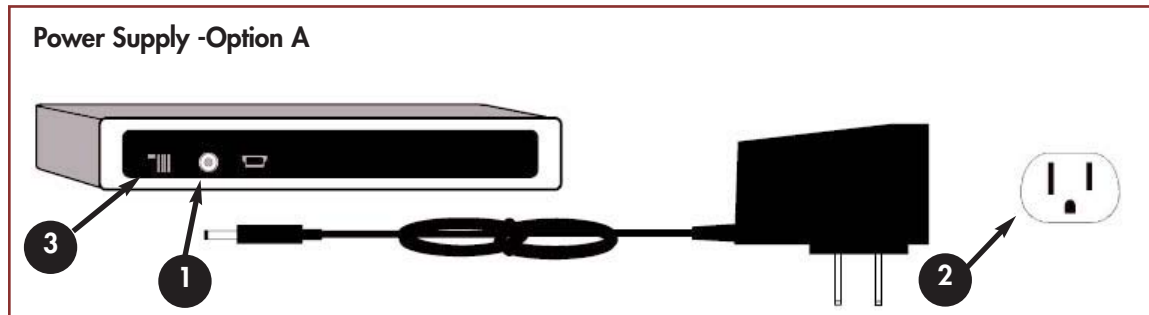

- 1 Insert the round end of the external power supply into the port on the rear of your drive.
- 2 Plug the large end of the external power supply into a properly grounded electrical outlet.
- 3 Slide the switch to the "EXT" position.



**Warning!** Use only the AC adapter supplied with your specific LaCie drive. Do not use a power supply from another LaCie drive or another manufacturer. Using any other power cable or power supply may cause damage to the device and void your warranty. Always remove the AC adapter before transporting your LaCie drive. Failure to remove the adapter may result in damage to your drive and will void your warranty.

## Option B

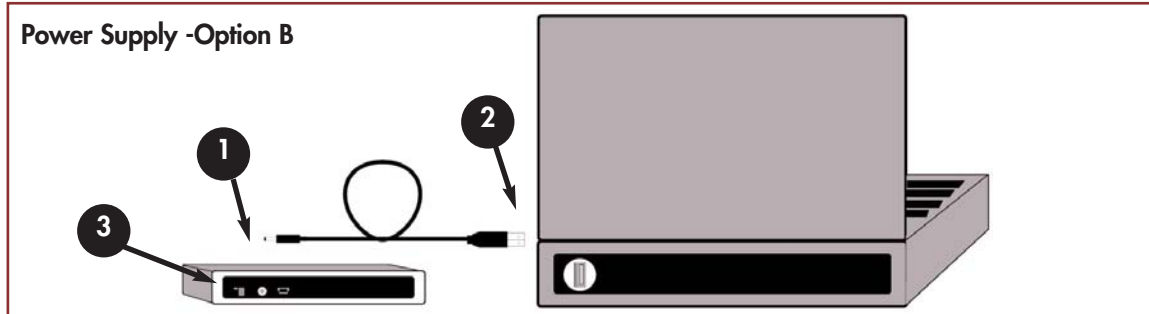

- 1 Insert the round end of the USB Power Sharing Cable into the port on the rear of your drive.
- 2 Insert the USB end of the power sharing cable into an available USB port\* on your computer.
- 3 Slide the switch to the "USB" position.

**i Important Note:** \*In order for the USB Power Sharing Cable to draw a sufficient amount of power from your computer, it must be plugged into a powered USB port.

### Step 2.3. –

**Connect the USB 2.0 cable to your LaCie Drive and to your computer.**

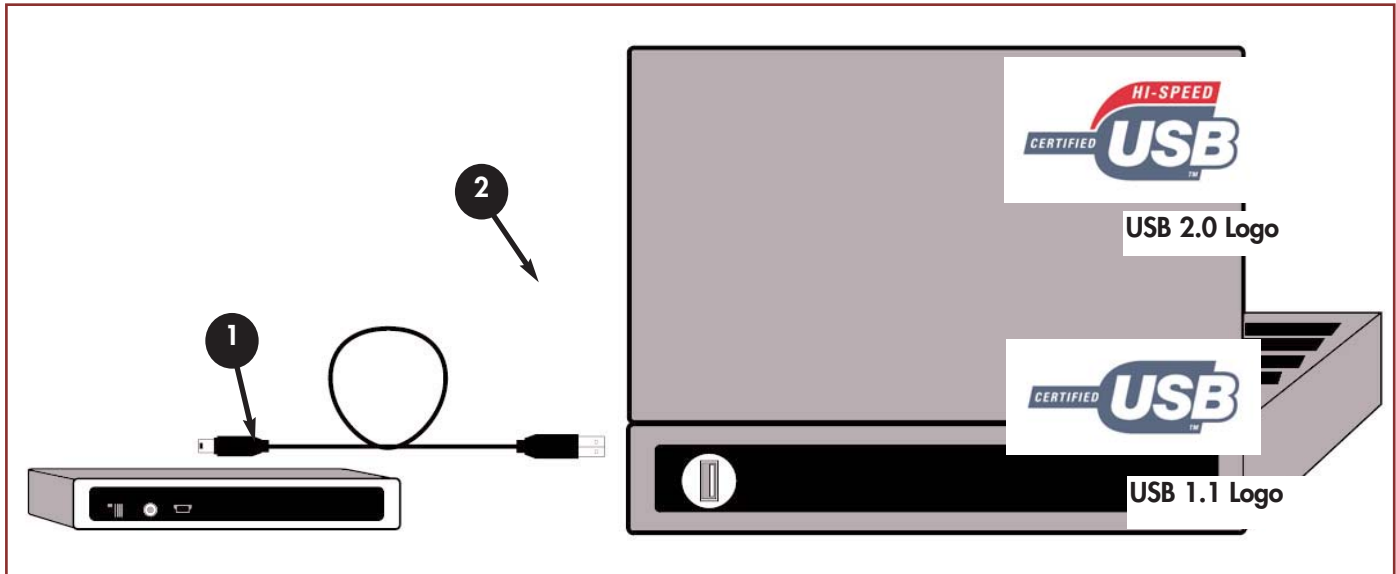

- 1** Examine the cable carefully and make sure that you have the USB 2.0 cable properly aligned, then insert the cable firmly into the USB port on the back of the drive for a stable connection.
- 2** Look for a USB 2.0\* logo (which generally is used to identify the port) next to the connector on the front or back of your computer, then insert the cable firmly into the USB port for a stable connection.



**Tech Note:** Please refer to section [4.1 Advice for Optimizing USB 2.0 Connections](#) for important information on disconnecting USB 2.0 devices and ensuring optimum performance.



**Tech Note:** \*To achieve USB 2.0 speeds, your drive must be connected to a USB 2.0 host port. If it is connected to a USB 1.1 port, your drive will operate at USB 1.1 speeds. For more details, see [4.1 Advice for Optimizing USB 2.0 Connections](#).

## 3. Using Your LaCie DVD+/-RW Drive

### 3.1. Supported DVD/CD Formats

Your LaCie drive is compatible with most popular DVD and CD formats:

| Format                           | Type of Disc                           | Record | Read |
|----------------------------------|--|--------|------|
| <b>DVD</b>                       | DVD+R                                  | X      | X    |
|                                  | DVD+RW                                 | X      | X    |
|                                  | DVD-R 4.7GB for General use (Ver. 2.0) | X      | X    |
|                                  | DVD-ROM                                | --     | X    |
|                                  | DVD-R 3.95GB, 4.7GB for Authoring      | --     | X    |
|                                  | DVD-R (General use only for write)     | X      | X    |
|                                  | DVD-RW (General use only for write)    | X      | X    |
|                                  | DVD-ROM (single and dual layer)        | --     | X    |
|                                  | DVD (single and dual layer) 80 mm disc | --     | X    |
|                                  | <b>CD</b>                              | CD-R   | X    |
| CD-RW (supports AM2)             |  | X      | X    |
| CD-ROM                           |  | --     | X    |
| CD-ROM XA Mode2 (form 1, form 2) |  | --     | X    |
| CD-Extra                         |  | --     | X    |

Use your LaCie DVD+/-RW Drive to:

- Create audio CDs
- Create a DVD-Video
- Create data CD/DVDs
- Create a backup
- Duplicate a CD/DVD

Ideal recording techniques:

- Close all other open programs and disconnect from the internet;
- Copy data to your hard drive first;
- Use the correct media with the appropriate speed rating;
- Use media that is free of scratches and fingerprints;
- See our Web site for a list of LaCie recommended media.

Check LaCie's Web site ([www.lacie.com](http://www.lacie.com)) often for the latest information on creating CDs and DVDs.

### 3.1.1. CD and DVD Media Definitions

Your LaCie DVD+/-RW Drive will let you create, save and share your digital files to CD-R/RW, DVD-R/RW and DVD+R/RW media. The included software will allow you to format and write to both CD-R/RW, DVD-R/RW and DVD+R/RW discs.

#### CD-R Discs:

- Best suited for: recording audio CDs, store photos and data CDs.
- Files can not be deleted from CD-R discs, and you cannot write over existing files on a CD-R disc.

#### CD-RW Discs:

- Best suited for: passing medium sized files around an office or among students.
- Discs can be reformatted up to 1,000 times, and files can be written over.
- Most CD-ROM drives and audio CD players cannot read CD-RW discs.

#### DVD-R Discs:

- Best suited for: recording DVD videos, storing multiple photo albums and large data CDs.
- These discs have the same write-once concept as CD-R media, but with 4.7GB of capacity versus 700MB for CD-R discs.
- There are two types of DVD-R discs: DVD-R General, which are intended for home applications, and DVD-R Authoring, which are intended for professional DVD-Video development applications.

#### DVD-RW Discs:

- Best suited for: backing up and archiving larger digital content.
- These discs serve the same general purpose as CD-RW media, but with 4.7GB of space versus 650MB.
- Discs can be written and erased up to 1,000 times.

#### DVD+R Discs:

- Best suited for: recording DVD videos, storing multiple photo albums and large data CDs.
- These discs are also functionally similar to CD-R media, and have the same capacity as DVD-R discs.
- DVD+R utilizes a different technology than DVD-R: supports "lossless linking" and the combination of Constant Angular Velocity (CAV) and Constant Linear Velocity (CLV) recording techniques.

#### DVD+RW Discs:

- Best suited for: backing up and archiving larger digital content.
- These discs are functionally similar to CD-RW and DVD-RW discs, but utilizes the same recording techniques as DVD+R.
- Incorporates the Direct Overwrite (DOW) system, allowing data to be written directly over existing data in a single pass.

### 3.1.2. DVD-Video Zone

Nearly all commercially-available DVD discs feature a Region Protection Code (RPC). In order to watch DVD-Video discs, the RPC needs to match the setting on the DVD player. By default, all LaCie DVD-Video-compatible drives are set to the RPC zone of the country in which it was purchased. This RPC setting may be changed using your hardware or software MPEG-II decoder (please refer to the documentation supplied with your decoder for more information). DVD-Video discs that do not feature RPC II encoding may be played on all DVD players set to Zone 1.

The worldwide RPC zones are:

|               |   |
|---------------|---|
| <b>Zone 1</b> | USA and Canada                                    |
| <b>Zone 2</b> | Europe, Japan, the Middle East and South Africa   |
| <b>Zone 3</b> | Southeast Asia (including Hong Kong)              |
| <b>Zone 4</b> | Australia, New Zealand, Central and South America |
| <b>Zone 5</b> | Northwest Asia, North Africa                      |
| <b>Zone 6</b> | China   |

When you insert a DVD-Video disc into your drive for the first time, the hardware or software MPEG-II decoder will detect if the setting of your drive is the same as on the DVD-Video. If not, a message will appear on your screen and you will be asked to change the RPC setting of your drive.



**Important Note:** You can only change the RPC of your drive four times. The RPC setting is copied into an internal component in the drive. This chip makes an average of the first five readings and sets the drive to the most read zone. After this, it will not be possible to change or reset the RPC of the drive.

**Example:** You change the RPC Zone to play a Zone 1 DVD-Video, and then you change to a Zone 2 DVD-Video. You switch back and forth between the zones a total of five times, twice in Zone 1 and three times in Zone 2. Your drive will then be set on Zone 2, without the possibility to reset the drive later on in order to view DVD-Video discs from Zone 1.



## 3.2. Inserting Discs

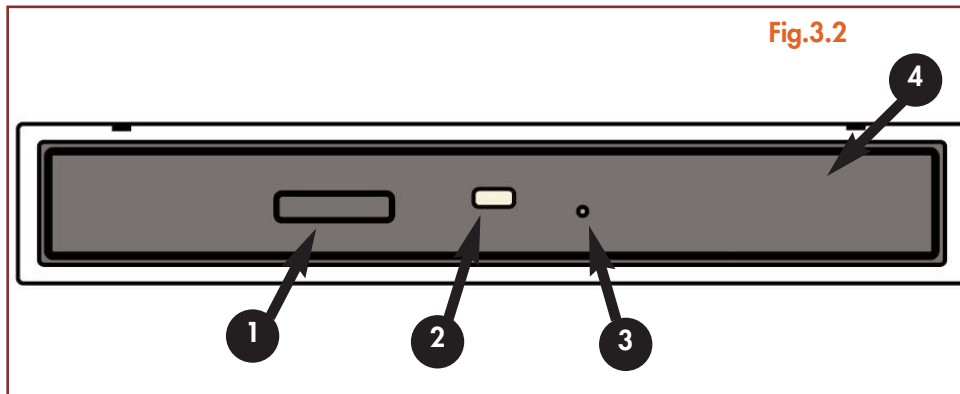

- 1 Open/Close Button
- 2 Activity LED
- 3 Emergency Eject Hole
- 4 Media Tray

To insert a disc, push the Open/Close (#1) button on your LaCie DVD+/-RW Drive. When the disc tray opens, put the DVD or CD media into the tray with the label side facing up. Make sure the DVD or CD is correctly placed in the center of the disc tray. Gently push in the disc tray or push the Open/Close button to close it.

Do not attempt to force the door open, you will damage the drive. The power must be on in order to open the drive. The drive must be on a flat surface to work correctly.

To close your LaCie DVD+/-RW Drive, press the Open/Close button on the front of the drive.



### Warning!

- Do not force the tray closed. You will damage the drive.
- Always remove discs before transporting the drive.
- Never move the drive while it is in operation.

### 3.3. Ejecting Discs



**Warning!** Do not attempt to open the drive's disc tray or remove the DVD or CD while the unit is in use and being accessed by the computer. You may injure yourself, and damage the drive and/or your computer system. Do not transport the drive with the tray open or with a DVD or CD inside it. Doing so may damage the drive and/or data stored on the disc, and will void your warranty.

#### **Windows Users**

After you have finished using the DVD+/-RW drive and the computer is no longer accessing it, push the Open/Close button ([fig.3.2 #1](#)). When the disc tray is fully open, remove the DVD or CD. After removing the disc, gently push in the disc tray or push on the Open/Close button to close it.

You can also go into **My Computer** and right-click the DVD+/-RW drive icon. In the drop-down menu that follows, select the **Eject** option. The disc tray will open, then you can access your media.

#### **Mac Users**

Drag the DVD/CD icon on the desktop to the **Trash**. The DVD+/-RW drive's tray will then open. Remove the DVD or CD. Gently push in the disc tray or push the load/eject button to close it.

### 3.4. Emergency Ejection of Discs

In the event that a CD or DVD cannot be ejected with the Open/Close button and the software is not controlling the drive, use the emergency eject operation to open the disc tray. First, switch off your computer and the DVD+/-RW drive and unplug the drive's power.



**Warning!** Make sure the DVD+/-RW drive is off and the power unplugged before attempting the emergency ejection procedure.

On the front of the drive is the Emergency Eject Hole ([fig.3.2 #3](#)). Insert a small metal poker, such as an unbent paper clip, into the Emergency Eject Hole until the poker presses against the manual eject mechanism. You will feel the mechanism eject the disc tray. Only use this method when the Open/Close button is not working.

## 3.5. Accessing Discs

### **Windows Users**

The CD or DVD volume will appear in **My Computer**. Click on **My Computer** to view the contents of the CD or DVD and to have access to the folders and files on it.

You can also gain access to the files and folders contained on the disc by going into Windows **Explorer** and clicking on the CD/DVD-ROM drive icon.

### **Mac Users**

The CD or DVD volume will appear as an icon on the **Desktop**. Click on the icon to have access to the contents of the CD or DVD.



**Important Note:** *At the time of publication, if your Mac does not have a native, built-in DVD-ROM or Combo (CD-RW and DVD-ROM) Drive, Apple does not support DVD-Video playback over external, third-party DVD drives.*

## 3.6. Writing Discs

The following is a brief overview of some of the recording terminology to help you understand how to use your drive to write discs.



**Important Note:** *Please refer to your recording software's user's guide for information on how to best use your DVD+/-RW drive in write mode.*

### 3.6.1. DVD+/-R/RW Writing Methods

**Disc at Once (DAO)** - A DVD writing process in which the entire DVD is recorded in one session, and data cannot be added after the recording is finished. Differs from the CD-R DAO method because the lead-in, data area and lead-out areas are all written sequentially.

**Incremental Recording (IR)** - A DVD writing process that is similar to the Session at Once (SAO) CD-R writing method; files may be added directly to the DVD-R disc one recording at a time, instead of recording the files to a hard drive before writing the disc. The minimum recorded size, though, must be at least 32KB (even if the file to be recorded is smaller than that), and capacities and write speeds are decreased due to the overhead of combined lead-in/out areas and data. Also, the disc must be finalized before it may be played back by a drive other than the drive recording the disc.

**Multi-Border Recording (MBR)** - A DVD writing process that is very similar to IR, MBR allows you to make an IR disc and then play the disc back on a device that recognizes this type of recording method. MBR creates a very short boundary zone around a recording session so a compatible player or DVD-ROM drive does not attempt to play beyond the border of the recorded area, instead allowing the unfinalized disc to be read by a player that supports this recording method.

**Restricted Overwriting (RO)** - A DVD writing process that only applies to DVD+/-RW discs. With this method, if a disc has already been written to, new data segments can be randomly inserted anywhere within the recorded boundary. New data, however, can only be added to an area of the disc that has already been recorded over and from the point where the last session was stopped.



**Tech Note: \*Buffer Underrun** - The recording of a disc is a system-intensive application, and the rewritable drive needs a constant stream of data. A buffer underrun occurs when the stream of data to the rewritable drive is not fast enough to keep the rewritable drive's buffer full, causing the an error in the recording process. If this problem occurs often, turn down the recording speed and consult section [4.1.3 Data Transfers](#).

### 3.6.2. CD-R/RW Writing Methods



**Important Note:** Please refer to your recording software's user's guide for information on how to best use your DVD+/-RW drive in write mode.

**Disc at Once (DAO)** - A CD writing process in which the entire CD is recorded in one session, and data cannot be added after the recording is finished. This mode allows for the most control of the recording process for audio CDs because the gap between tracks can be set and the maximum capacity of the CD can be utilized.

**Packet Writing (PW)** - A CD writing process that is very useful for data backup, but cannot be used to write audio CDs. Buffer underrun\* is impossible in this mode, because the data is written in "packets" of a few KBs.

**Session at Once (SAO)** - A CD writing process which is similar to DAO, where all of the information is written in one session, but SAO allows for the ability to begin another session and record at a later time. This mode allows for greater control of the recording process than PW or TAO, and more disc space can be utilized because there is no need for gaps between tracks.

**Track at Once (TAO)**- A CD writing process where data is added one track at a time, and the data can be added at a later time. The CD being written to, though, can only be read in the CD rewritable drive that is recording it until the disc is finalized (meaning that no more data can be added). There is also a gap of 2 seconds added between tracks, which will be heard as noise in some audio players.



**Tech Note: \*Buffer Underrun** - The recording of a disc is a system-intensive application, and the rewritable drive needs a constant stream of data. A buffer underrun occurs when the stream of data to the rewritable drive is not fast enough to keep the rewritable drive's buffer full, causing the an error in the recording process. If this problem occurs often, turn down the recording speed and consult section [4.1.3 Data Transfers](#).

## 4. Helpful Information

### 4.1. Advice For Optimizing USB 2.0 Connections

The following technical information relates to your LaCie Drive and gives some practical advice:

#### 4.1.1 What is USB 2.0?

The new USB 2.0 standard provides higher bandwidth for high-speed peripherals such as external hard drives, high-speed scanners and CD-RW drives. USB 2.0 delivers transfer rates up to 480Mb/s, while conveniently maintaining backward compatibility with USB 1.1 devices.



USB 2.0 can still be used to connect lower-speed USB 1.1 ports and devices like digital cameras, scanners, modems, keyboards, mice, joysticks and printers. In the USB 2.0 system, existing USB peripherals do not have to be upgraded, and lower-speed devices will not require additional performance, instead operating as USB 1.1 devices.



#### USB Cables and Connectors

Your LaCie drive is shipped with a USB 2.0-certified USB cable, to ensure maximum data transfer performance when connected to a USB 2.0 port. The cable will also work when connected to a USB 1.1 port, but drive performance will be limited to USB 1.1 transfer rates.

There are also different types of USB connections, such as the mini-cable and device end. Make sure that you have the correct type of connection on computer. Consult LaCie Customer Support or your LaCie reseller for more information.

#### USB 2.0 Host Bus Adapters and Performance

To utilize the newly-enhanced USB 2.0 performances, your computer must be equipped with a USB 2.0 host bus adapter card (sold separately, such as the LaCie USB 2.0 PCI Card, or integrated by your PC manufacturer) and the appropriate drivers. These host bus adapter cards, which include one or more USB ports, are shipped with special USB 2.0 drivers that enable the computer to control the card. These drivers must be installed in order for USB 2.0 devices connected to the port to work at their correct speeds. For installation instructions, please refer to the documentation that comes with the host adapter card.

LaCie supplies only the appropriate USB 2.0 drivers for its peripherals and does not provide drivers for third-party host adapter cards. To obtain the right drivers for your host adapter card, visit your card manufacturer's Internet site.

### 4.1.2. Disconnecting USB 2.0 Devices

USB 2.0 external devices feature "plug & play" connection. This means that your drive can be connected and disconnected while the computer is running. To prevent failures, it is important you follow these steps when disconnecting your USB 2.0 device.

#### Windows Users



**Important Note: Windows 98 SE Users:** *If you have installed the **Windows Storage Supplement Update**, you will have to unmount the drive before disconnecting it or powering it down. If you have not installed the update, simply disconnect the drive when it is not active. No unmounting is required.*

1) From the **System Tray** (located in the lower right-hand side of your screen), click on the **Eject** icon (a small green arrow over a hardware image).

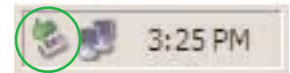

**Fig.4.1.2**

2) A message will appear, detailing the devices that the **Eject** icon controls, i.e. "Safely remove..." Click on this prompt.

3) You will then be given the following message: "Safe to Remove Hardware" (or similar). It is now safe to disconnect the device.

#### Mac Users

You must unmount the drive before disconnecting it or powering it down. Drag the disc icon to the **Trash**. Once the device's icon no longer appears on the desktop, the drive can be disconnected.

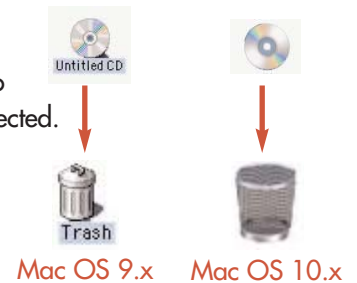

### 4.1.3. Data Transfers

Data transfers are the flow of data that accomplishes a task, usually related to moving data from storage to computer RAM or between storage devices. During data transfers, it's best to wait before launching other applications on the same USB 2.0 port. Anomalies may arise with computers that have USB 2.0 controllers\* that do not conform to OHCI (Open Host Controller Interface) standards. In any other configurations, we cannot ensure 100% correct operation. Due to this, you may encounter hanging problems. If this happens, proceed as follows:

1) Make sure that the USB 2.0 cable is connected tightly and securely on both ends of the cable, from the drive to the computer. If you are using a USB 2.0 cable other than the one supplied with your LaCie drive, check that it is USB 2.0 certified. The cable that is provided with your LaCie drive is USB 2.0 certified.



**Warning!** *Do not connect USB 2.0 cables so that they form a ring of devices. There is no need for terminators on USB 2.0 devices, so the unused USB 2.0 connectors should be left empty.*

2) Check that the power supply and ground connection are seated properly.

3) Disconnect your computer's USB 2.0 cable. Wait 30 seconds. Reconnect.



**Tech Note: \*Controller** - *This is a component or an electronic card (referred to in this case as a "controller card") that enables a computer to communicate with or manage certain peripherals. An external controller is an expansion card which fills one of the free slots (i.e. PCI or PCMCIA) inside your PC and which enables a peripheral (i.e. CD-R/RW drive, Hard Drive, scanner or printer) to be connected to the computer. If your computer is not equipped with a USB 2.0 controller card, you can purchase an external controller through LaCie. Contact your LaCie reseller or LaCie Technical Support ([6. Contacting Customer Support](#)) for more information.*

## 4.2 User Advice on MPEG-II Decoders

All DVD-Video material is compressed using MPEG-II compression. DVD-Video, with full-motion video and multi-channel sound (multi-lingual soundtracks, surround sound, etc.), is a data-hungry application. Without compression, you would only be able to fit a 5-minute movie onto a 4.5GB disc (the DV format is equivalent to 13GB per hour). MPEG-II compression allows you to fit a full-length feature film, plus bonus material, on just one disc.

In order to play DVD-Video discs using your LaCie DVD+/-RW Drive, you need to have an appropriate MPEG-II decoder. You have two options:

- 1) Install the MPEG-II decoder software if your PC is equipped with a processor that is 400MHz or faster. The decoder software will give you smoother images when playing DVD-Video discs using your drive (as with any application, the more RAM you have, the better playback performance will be).
- 2) Purchase and install a PCI MPEG-II decoder card if your PC is equipped with a processor that is 400MHz or slower. The decoder card should help you obtain better performance during playback with your LaCie drive.

## 4.3 File System Formats - Definitions

When writing DVD+/-R/RW and CD-R/RW discs, you will have the option to assign the disc a particular file format (the way in which a computer names and organizes files for storage and retrieval). There are essentially three file system formats to be concerned with when using a LaCie DVD or CD Drive:

- Universal Disk Format (UDF)
- ISO 9660
- Mac OS Extended

**UDF** - This file system was developed to ensure consistency between various optical media, compatibility across platforms and among various CD and DVD applications. UDF is used by DVD to contain MPEG audio and video streams, and is required by DVD-ROMs.

**ISO 9660** - This is the standard file system for CD-ROMs, which allows them to be read on a Mac, PC or other major computer platform. Microsoft created an extension to the format, called Joliet, which allows for Unicode file character names and file names up to 64 characters in length (twice as many as the ISO 9660 Level 2 and 3 specifications).

**Mac OS Extended** - Also known as HFS+, this is the file system used by Mac OS 8.1 and higher. If you will be using your disc only on Macs, this is the preferred file format.



## 5. Troubleshooting

In the event that your LaCie DVD+/-RW Drive is not working correctly, please refer to the following checklist to find out where the problem is coming from. If you have gone through all of the points on the checklist and your drive is still not working correctly, please have a look at the FAQs that are regularly published on our Web site – [www.lacie.com](http://www.lacie.com). One of these FAQs may provide an answer to your specific question. You can also visit the drivers pages, where the most recent software updates will be available.

If you need further assistance, please contact LaCie Technical Support (see [6. Contacting Customer Service](#) for details).

### Manual Updates

LaCie is constantly striving to give you the most up-to-date, comprehensive User's Manuals available on the market. It is our goal to provide you with a friendly, easy-to-use format that will help you quickly install and utilize the many functions of your new device.

If your manual does not reflect the configurations of the product that you purchased, please check our Web site for the most current version available.

| The Issue                           | Questions to Ask   | Possible Solutions  |
|-------------------------------------|--|---|
| <b>The drive is not recognized.</b> | Is the drive's power on?   | Check to see that all of the power cords are properly connected and that the switch on the rear of the drive is turned on. If you are using a surge protector, make sure that it is switched on, too.   |
|                                     | Does an icon for the drive appear on the computer (On a Mac a CD-ROM must be inserted in the drive)? | Check for an icon on the Desktop (on a Mac) or in <b>My Computer</b> (on a PC).   |
|                                     | Are all of the cables connected securely and correctly?  | Make sure that all the steps in section <a href="#">2. Getting Connected</a> have been followed correctly. Examine the connections carefully to ensure that all the cables are inserted in the correct orientation and in the correct location. |
|                                     | Are both ends of the USB 2.0 cable connected and properly seated?                                    | Check both ends of the USB 2.0 cable. Disconnect them, wait 10 seconds, and reconnect them. If the drive is still not recognized, restart your computer and try again.  |

| The Issue  | Questions to Ask   | Possible Solutions  |
|--|--|---|
| The drive is not recognized.   | Are the USB 2.0 drivers installed correctly and enabled?     | <b>Mac Users:</b> Open <b>Apple System Profiler</b> and click on the <b>Devices and Volumes</b> tab. If your device is not listed, recheck the cables and try the other troubleshooting solutions listed here.  |
|  <b>Tech Note: Mac Users:</b> Apple is constantly providing updated support for drive mechanisms within OS 10.x. To ensure that you have the latest support, upgrade to the latest version of OS 10.x. To access the latest updates and upgrades, pull down the <b>Apple Menu</b> and click on <b>System Preferences</b> . In the section titled <b>System</b> , click on <b>Software Update</b> and then click <b>Update Now</b> . Your computer will then automatically connect via the Internet to access the latest updates from Apple. |  |   |
|  <b>Tech Note: Windows Users:</b> Microsoft consistently posts updated drivers and support fixes for their operating systems. Go to Microsoft's Web site, <a href="http://support.microsoft.com">support.microsoft.com</a> , for more information.  |  | <b>Windows 98 SE &amp; Me Users:</b> Go to <b>Start &gt; Settings &gt; Control Panel &gt; System &gt; Device Manager &gt; USB Controller</b> > click on the plus sign next to the controller icon, and you should see your device listed.                                 |
|  |  | <b>Windows 2000 Users:</b> Go to <b>Start &gt; Settings &gt; Control Panel &gt; System &gt; Hardware tab &gt; Device Manager button &gt; USB Controller</b> > click on the plus sign next to the controller icon, and you should see your device listed.                  |
|  |  | <b>Windows XP Users:</b> Go to <b>Start &gt; Control Panel &gt; Performance and Maintenance &gt; System &gt; Hardware tab &gt; Device Manager button &gt; USB Controller</b> > click on the plus sign next to the controller icon, and you should see your device listed. |
|  | Is there a conflict with other device drivers or extensions? | If you cannot see the device, recheck the cables and try the other troubleshooting solutions listed here.<br><br>Consult LaCie Technical Support. See section <a href="#">6. Contacting Customer Support</a> for more details.  |

| The Issue   | Questions to Ask  | Possible Solutions   |
|---|---|--|
| <p data-bbox="97 240 284 310"><b>The drive is not recognized.</b></p>  <p data-bbox="250 407 767 548"><b>Tech Note:</b> You will find important information about the compatibility of LaCie DVD+/-RW Drives and iTunes and Disc Burner at Apple's Web site: <a href="http://www.apple.com">www.apple.com</a>.</p> | <p data-bbox="384 240 778 310">Is there a conflict with other device drivers or extensions?</p> | <p data-bbox="788 240 1484 423"><b>Mac OS 9.x Users:</b> If your LaCie drive is not being recognized by the recording software, you may be experiencing an extension conflict between the software and <b>iTunes</b> or <b>Disc Burner</b>. There are two possible solutions to this problem.</p> <p data-bbox="788 444 1484 514">If you do not plan on using iTunes or Disc Burner, follow these steps:</p> <ol data-bbox="788 526 1484 857" style="list-style-type: none"><li data-bbox="788 526 1484 596">1) From the <b>Apple Menu</b>, go to <b>Control Panels</b> and open the <b>Extensions Manager</b>.</li><li data-bbox="788 607 1484 721">2) Scroll down to the <b>Extensions</b> folder and disable (uncheck) the <b>USB Authoring Support</b> and the <b>FireWire Authoring Support</b>.</li><li data-bbox="788 732 1484 769">3) Click on the <b>Restart</b> button to restart your computer.</li><li data-bbox="788 781 1484 857">4) Launch the recording software again, and check to see if it recognizes the drive now.</li></ol> <p data-bbox="788 867 1484 980">If you plan on using both the recording software and <b>iTunes</b> or <b>Disc Burner</b>, you may want to create a separate <b>Extension Set</b> for the recording software.</p> <ol data-bbox="788 997 1484 1354" style="list-style-type: none"><li data-bbox="788 997 1484 1073">1) From the <b>Apple Menu</b>, go to <b>Control Panels</b> and open the <b>Extensions Manager</b>.</li><li data-bbox="788 1084 1484 1122">2) Press the <b>Duplicate Set</b> button.</li><li data-bbox="788 1133 1484 1170">3) Give the new <b>Extension</b> set a name, such as <b>Writing</b>.</li><li data-bbox="788 1182 1484 1295">4) Scroll down to the <b>Extensions</b> folder, and disable (uncheck) the <b>USB Authoring Support</b> and the <b>FireWire Authoring Support</b>.</li><li data-bbox="788 1307 1484 1354">5) Click on the <b>Restart</b> button to restart your computer.</li></ol> <p data-bbox="788 1365 1484 1474">Now when you want to use this set, simply go back into <b>Extensions Manager</b>, and from the pull-down menu from <b>Selected Sets:</b>, choose your new Extension set.</p> |

| The Issue  | Questions to Ask  | Possible Solutions  |
|--|---|---|
| <p><b>The drive's media tray will not open.</b></p>  | <p>Are you using a Mac?</p>   | <p>Drag the Disc icon onto the <b>Trash</b> icon. The disc will eject automatically. If this does not work, try using the eject function of the software program that you are using.</p>  |
|  | <p>Has a running software program locked the eject function?</p>                                    | <p>To check, disconnect the FireWire cable, then reconnect and press the Open/Close button.</p> <p>If the disc will still not eject, go to section <a href="#">3.4 Emergency Ejection of Discs</a> for more instructions on how to eject your media.</p>  |
| <p><b>The drive automatically ejects a disc when you try to record on it, or the drive is not writing to CD/DVD correctly.</b></p> | <p>Is the disc already full?</p>  | <p>Verify the contents of the disc by using your recording software or viewing its contents in <b>My Computer</b> for Windows users, or <b>File &gt; Get Info</b> for Mac users. If you've checked and it still won't record, try recording on a new blank disc.</p>  |
|  | <p>Does the drive support the format of the disc you have inserted?</p>                             | <p>Check section <a href="#">3.1 Supported DVD/CD Formats</a> for the disc formats supported by your drive.</p>   |
|  | <p>Is the disc damaged?</p>   | <p>Carefully inspect the disc. Look to see if there are highly visible scratches to the recording surface (the bright shiny side) of the disc. If in doubt, try another disc.</p>   |
|  | <p>Has the recording software been installed correctly?</p>   | <p>Double-check the installation of your recording software and reinstall the recording software, if necessary. Review the recording software's troubleshooting and help sections for further tips.</p>   |
|  | <p>Has buffer underrun occurred (has something interrupted the stream of data to the recorder)?</p> | <ul style="list-style-type: none"> <li>• Disable all other software programs that are running during the recording session.</li> <li>• Disconnect the network, if you are using one. On a Mac, deactivate <b>File Sharing</b>.</li> <li>• Check to see that your hard drive is fast enough.</li> <li>• If recording from CD or DVD-ROM to disc, make sure that the speed of the source device is high enough to provide a sufficient data stream to the LaCie drive. Reduce the write speed of the LaCie drive using the appropriate menu in the recording software.</li> </ul> |

| The Issue                                       | Questions to Ask   | Possible Solutions  |
|---|--|---|
| DVD-Video playback will not work.               | Are you using a Mac?   | This is normal. For legal reasons, if you do not have a built-in DVD-ROM or Combo Drive, your LaCie DVD Drive cannot currently be used for DVD-Video playback on a Mac.   |
| DVD-Video playback will not work under Windows. | Have you installed the appropriate MPEG-II decoder software?                             | Ensure that the MPEG-II software has been installed correctly. See the help section of the software program for more information.   |
|   | Do you have a Pentium II 350 MHz (or equivalent) processor or greater?                   | Check your processor ( <b>Start &gt; Settings &gt; Control Panel &gt; System &gt; General</b> tab.) If your processor does not meet the minimum requirements (see section <a href="#">1.1 Minimum System Requirements</a> ), you may need to purchase an MPEG-II decoder card. Consult your computer supply specialist for details. |
|   | Has the LaCie drive been set as the default DVD drive in your DVD playback software?     | Consult the help section of your DVD playback software for information on how to configure your drive as your computer's default DVD player.  |
|   | Are you running other software programs simultaneously?                                  | Check to see if other programs are running. If so, close them. Depending on your computer's configuration, playback may be possible only if the DVD player software is the only program running.  |
| DVD playback is not as smooth as it should be.  | If using Windows, do you have a Pentium II 350 MHz (or equivalent) processor or greater? | Check your processor ( <b>Start &gt; Settings &gt; Control Panel &gt; System &gt; General</b> tab.) If your processor does not meet the minimum requirements (see section <a href="#">1.1 Minimum System Requirements</a> ), you may need to purchase an MPEG-II decoder card. Consult your computer supply specialist for details. |
|   | Are you running other software programs simultaneously?                                  | Check to see if other programs are running. If so, close them. Playback may become smoother when only the DVD player software is running.   |

| The Issue  | Questions to Ask   | Possible Solutions  |
|--|--|---|
| <p><b>The USB 2.0 drive is not running noticeably faster than a USB 1.1 drive.</b></p> | <p>Is the drive connected to a USB 1.1 port on your computer, or to a USB 1.1 hub?</p> | <p>If so, it is normal that the drive runs at USB 1.1 speeds. A USB 2.0 device can only run at USB 2.0 speeds when connected to a USB 2.0 port or hub and controlled by the appropriate USB 2.0 drivers.</p>  |
|  | <p>Is the drive connected to a USB 2.0 port on your computer?</p>                      | <p>Check to see that the USB 2.0 drivers for your Host USB 2.0 port and for your USB 2.0 device have been correctly installed (see the <a href="#">4.1.1 What Is USB 2.0?</a> section for a more detailed discussion). If in doubt, uninstall the driver and then reinstall it.</p> |
|  | <p>Does your computer or operating system support USB 2.0?</p>                         | <p>See the <a href="#">4.1.1 What Is USB 2.0?</a> section for a more detailed discussion.</p>   |



**Tech Note:** Technically, you can connect up to 127 devices to a single USB bus. For more than two devices, you must make new connections using a peripheral called a "hub." A hub, which you hook up directly to a USB connector on your computer, usually has 4 or 7 output connections enabling you to connect the same number of peripherals. One of the hub's main functions is to regenerate signals that lose part of their strength as they are transmitted via the USB cable. By connecting yet another hub to a connector on the existing hub, you can then plug in a new set of peripherals and so on, up to a maximum of 127.

You can use your USB 2.0 devices with USB 1.1 hubs, but the peripherals will be limited to USB 1.1 performance levels. As USB 2.0 is backwards compatible, you will be able to connect USB 1.1 devices to USB 2.0 hubs; however, the USB 1.1 devices will still maintain their normal performance levels (i.e. 12 Mb/s).

In practice, users who desire enhanced USB 2.0 throughput will need to connect their USB 2.0 hardware on both ends of a 2.0 hub to achieve the "high-speed" mode. On one end, a USB 2.0 compliant host controller resides on the host PC to manage the enumeration process and power management. On the other end, USB 2.0 hardware must be connected directly to the root hub or through a USB 2.0 hub.

Some hubs have no power supply and others are self-powered. When you choose a hub, opt for the self-powered variety, as they have their own AC adapter. The most powerful hubs provide 0.5A of power to each port. If you buy a hub, make sure that it supports per-port switching. This function prevents the entire chain of peripherals from freezing up if one of them is not working properly or is down.



**Important Note:** Avoid using USB connectors found on certain peripherals such as keyboards. These are passive (or pass-through) connectors that lead to power loss and unstable operation.

**Important Note:** Only use USB cables shorter than 5 meters (approximately 15 feet). Using longer cables cause the peripherals to malfunction due to excessive reduction in electrical signal strength.

## 6. Contacting Customer Support

### Before You Contact Technical Support

1) Read the manuals and review the [Troubleshooting](#) section.

2) Try to isolate the problem. If possible, make the drive the only external device on the CPU, and make sure that all of the cables are correctly and firmly attached.

If you have asked yourself all of the pertinent questions in the troubleshooting checklist, and you still can't get your LaCie drive to work properly, contact us via the provided Web link. Before contacting us, make sure that you are in front of your computer and that you have the following information on hand:

- Your LaCie drive's serial number
- Operating system(Mac OS or Windows) and version
- Computer brand and model
- Names of CD or DVD drives installed on your computer
- Amount of memory installed
- Names of any other devices installed on your computer

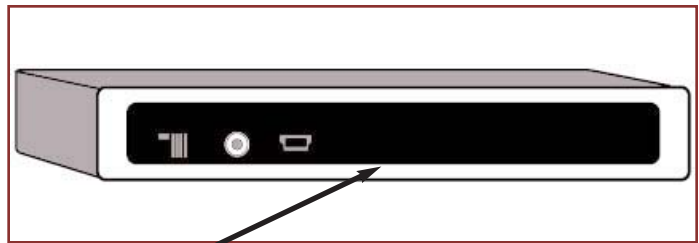

Serial Number Sticker

## LaCie Technical Support

### LaCie Australia

Contact Us At:

<http://www.lacie.com/au/contact/>

### LaCie Denmark

Contact Us At:

<http://www.lacie.com/dk/contact/>

### LaCie Germany

Contact Us At:

<http://www.lacie.com/de/contact/>

### LaCie Netherlands

Contact Us At:

<http://www.lacie.com/nl/contact/>

### LaCie Sweden

Contact Us At:

<http://www.lacie.com/se/contact/>

### LaCie USA

Contact Us At:

<http://www.lacie.com/contact/>

### LaCie Belgium

Contact Us At:

<http://www.lacie.com/be/contact/>

### LaCie Finland

Contact Us At:

<http://www.lacie.com/fi/contact>

### LaCie Italy

Contact Us At:

<http://www.lacie.com/it/contact/>

### LaCie Norway

Contact Us At:

<http://www.lacie.com/no/contact/>

### LaCie Switzerland

Contact Us At:

<http://www.lacie.com/chfr/contact>

### LaCie Grand Export

Contact Us At:

<http://www.lacie.com/intl/contact/>

### LaCie Canada (English)

Contact Us At:

<http://www.lacie.com/caen/contact/>

### LaCie France

Contact Us At:

<http://www.lacie.com/fr/contact/>

### LaCie Japan

Contact Us At:

<http://www.lacie.co.jp>

### LaCie Spain

Contact Us At:

<http://www.lacie.com/es/support/request>

### LaCie United Kingdom & Ireland

Contact Us At:

<http://www.lacie.com/uk/support/request>



## 7. Warranty

LaCie warrants your drive against any defect in material and workmanship, under normal use, for the period designated on your warranty certificate. In the event this product is found to be defective within the warranty period, LaCie will, at its option, repair or replace the defective drive.

This warranty is void if:

- The drive was operated/stored in abnormal use or maintenance conditions;
- The drive is repaired, modified or altered, unless such repair, modification or alteration is expressly authorized in writing by LaCie;
- The drive was subjected to abuse, neglect, lightning strike, electrical fault, improper packaging or accident;
- The drive was installed improperly;
- The serial number of the drive is defaced or missing;
- The broken part is a replacement part such as a pickup tray, etc.
- The tamper seal on the drive casing is broken.

LaCie and its suppliers accept no liability for any loss of data during the use of this device, or for any of the problems caused as a result. As a precaution, it is recommended that the CD-R/RW, DVD-R/RW and DVD+R/RW media be tested after they have been written to. Under no circumstances do LaCie or its suppliers guarantee the reliability of the DVD or CD media used in this drive.

LaCie will not, under any circumstances, be liable for direct, special or consequential damages such as, but not limited to, damage or loss of property or equipment, loss of profits or revenues, cost of replacement goods, or expense or inconvenience caused by service interruptions.

Any loss, corruption or destruction of data while using a LaCie drive is the sole responsibility of the user, and under no circumstances will LaCie be held liable for the recovery or restoration of this data.

Under no circumstances will any person be entitled to any sum greater than the purchase price paid for the drive.

To obtain warranty service, call LaCie Technical Support. You may be asked to furnish proof of purchase to confirm that the drive is still under warranty.

All drives returned to LaCie must be securely packaged in their original box and shipped with postage prepaid.

Register online for free technical support: [www.lacie.com/register](http://www.lacie.com/register)